



---

# MERLIN<sup>®</sup>

COMMUNICATIONS SYSTEM

INSTALLATION GUIDE:  
MODELS 206 AND 410

---

# Table of Contents

	<b>Page</b>
<b>Introduction</b>	2
<b>Getting Started</b>	3
<b>Installing the Control Unit</b>	6
Position the Control Unit	6
Set the Control Unit Switches	6
Connect the Control Unit to the AC Outlet	7
Prepare the Network Interface	8
Test the Outside Lines	9
Connect the Control Unit to the Network Interface	10
<b>Voice Terminal Wiring</b>	12
Jack Field Connection	12
Direct Connection	14
<b>Connecting the Voice Terminals</b>	15
Prepare the Voice Terminals	15
Connect Each Voice Terminal to the System	16
Test Each Voice Terminal for Dial Tone	18
Attach and Verify the Intercom Numbers	18
<b>Installing Accessories</b>	19
Cartridges	19
Other Accessories	20
<b>System Tests</b>	21
Place an Outside Call	21
Place an Intercom Call	22
<b>What's Next?</b>	23
<b>System Changes</b>	24
Adding an Outside Line	24
Adding a Voice Terminal	24
Moving a Voice Terminal	24
Changing Touch-Tone/Rotary Service	24
Upgrading from Model 206 to Model 410	25
<b>Troubleshooting</b>	26
Troubleshooting Table	26
General Test	29
<b>Appendix A: Interference Information</b>	30
<b>Appendix B: FCC Registration and Repair Information</b>	30
<b>Index</b>	31

---

# Introduction

This installation guide tells you how to install and test your MERLIN® communications system, Model 206 or 410. It leads you step by step through system installation, from a pre-installation checklist to system tests. You should perform the steps in the order in which they are presented because many of the earlier steps prepare the system for later steps.

When you complete the steps in this guide, see the administration manual that came with your system for programming and administration instructions. *Your system may not be fully operable until you have programmed and administered it.*

This guide includes the following sections:

- **Getting Started** describes how to prepare for system installation.
- **Installing the Control Unit** explains how to set up and connect the system's control unit.
- **Voice Terminal Wiring** provides instructions for connecting the system wiring.
- **Connecting the Voice Terminals** explains how to connect your voice terminals (MERLIN system telephones) to your system.
- **Installing Accessories** suggests some accessories you may want to consider adding to your system.
- **System Tests** provides tests to help you determine if you've installed your system properly.
- **What's Next?** refers you to documents that explain how to customize and use your system to meet your particular business needs.
- **System Changes** explains how to rearrange or alter your system once it is in place.
- **Troubleshooting** isolates and identifies specific system problems that could arise during installation, and suggests solutions to basic problems.

The steps in this guide are numbered in order of performance. To visualize a step as it is described, refer to the drawings accompanying the text. The numbers in the drawings correspond to the step numbers in the text. The control unit most often pictured in this guide is a Model 410, but the information presented usually applies to the Model 206 control unit as well. When there are exceptions, both control units are pictured.

# Getting Started

This guide assumes the tasks on the following list have been completed. *Review the list carefully.* If you have not completed the tasks on the list, do so now.

- Make sure the necessary wiring is in place.

You must have a network interface that links your MERLIN system to the local telephone company's lines. A telephone company representative should have installed your outside lines and labeled the network interface to indicate the telephone number for each outside line.

You must also have wiring that connects your voice terminal locations to your control unit location. If your voice terminal locations are close enough to your control unit to make direct connection practical, you may have planned to connect your voice terminals directly to the control unit with modular voice terminal cords and, if necessary, modular voice terminal extension cords. If you are planning to connect your voice terminals directly to the control unit, this guide tells you how to do so at the appropriate point in the installation sequence.

If conditions at your business make direct connections between your voice terminal locations and your control unit location impractical, then you have connected the locations through the building wiring. You may have had the necessary wiring professionally installed, or perhaps you did the wiring yourself following the instructions in the Wiring Installation Kit. In either case, you should now have building wiring that runs from the voice terminal locations to the control unit location. The wiring runs should end in modular wall jacks at the voice terminal locations and in a group of jacks mounted in one or two jack panel boxes (the "jack field") at the control unit location. Inside the right door (the one with the handle) of each jack panel box you should find a label indicating the wiring run number and endpoint location (for example, "w1 Reception area") for each jack in the jack field.

The drawing, *top right*, shows a direct connection between a voice terminal and the control unit. The drawing, *bottom right*, shows a voice terminal connected to the control unit through the building wiring.

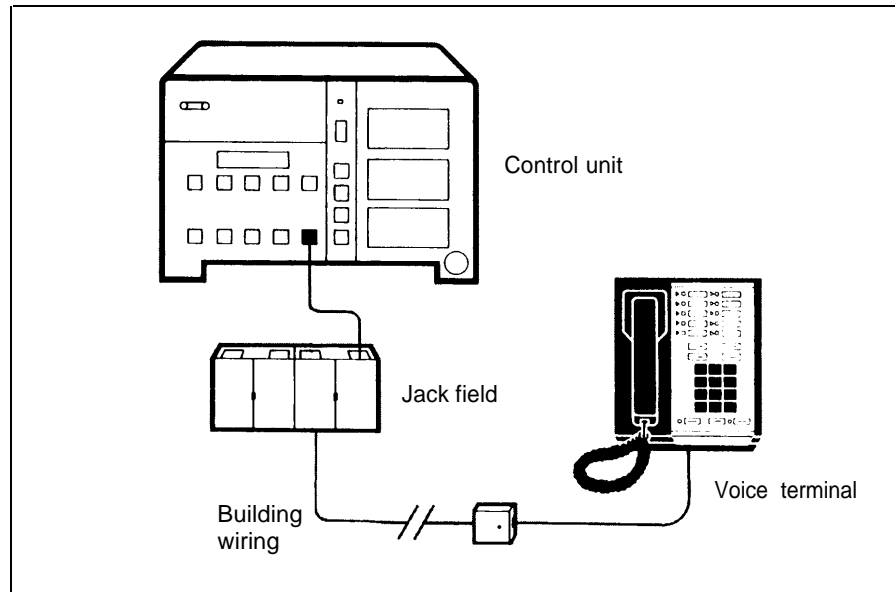
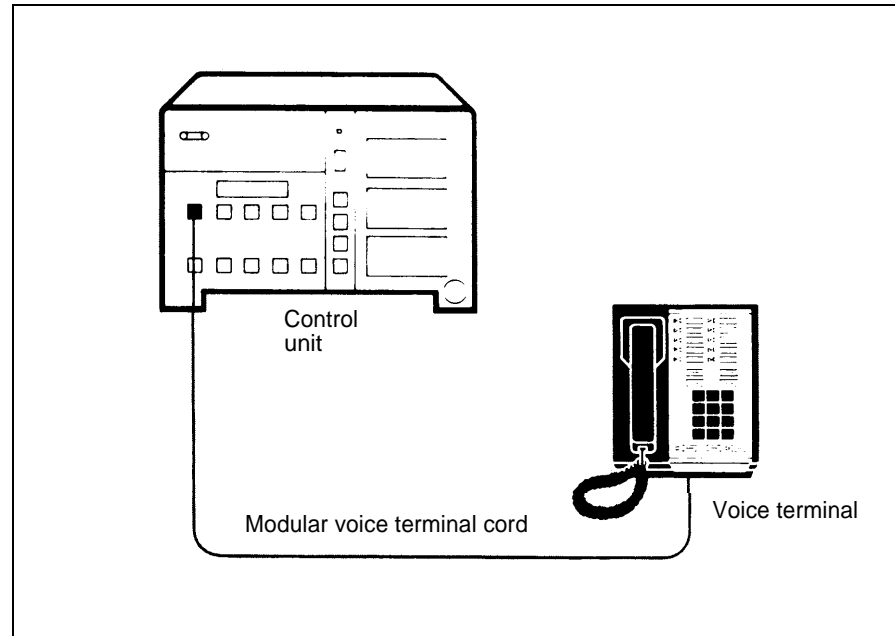

- Check the items in your shipment against your copy of the order form. Make sure the items and quantities agree. Save the instructions packed with components; you may need to refer to them later. And keep the packing boxes just in case you have to return components under warranty.
- Get acquainted with the system environment. Review the planning sheets you drew up when you ordered the system. Confirm the voice terminal locations, and make sure the control unit location meets the following environmental standards:
  - *Operating temperature:* 40-104°F (4-40°C)
  - *Humidity:* not to exceed 80%
  - *Ventilation:* Leave 6 inches of space above and to the sides of the control unit to prevent overheating. Keep the control unit away from sources of extreme heat (furnaces, heaters, attics, or direct sunlight). Do not stack multiple control units in rooms that are not air-conditioned; install them side by side at least 6 inches apart.
  - *Airborne contamination:* Do not expose the control unit to moisture, corrosive gases, dust, chemicals, or similar substances.

If your control unit location does not meet these standards, your warranty may become void.

- Become familiar with your MERLIN system. Review the figure of a simple MERLIN system configuration, *opposite page*, and note how components are related to one another.
  - 1 The **control unit** and the **cartridges** it contains provide the power and intelligence for all voice terminals and accessories.
  - 2 **Modular jumper cords** connect the control unit to the jacks in the jack field.
  - 3 The **jack field** serves as an interface between the control unit and the building wiring.
  - 4 **Building wiring** ties the whole system together, connecting the voice terminal locations to the control unit location.
  - 5 **Modular wall jacks** connect the voice terminals to the building wiring.
  - 6 **Modular voice terminal cords** connect the voice terminals to the modular wall jacks.
  - 7 **Voice terminals** provide telephone functions and access to the advanced features in the control unit.
  - 8 The **network interface jacks** provide connections to the local telephone company lines.
  - 9 **Line cords** connect the control unit to the network interface.
  - 10 The **ac outlet** is the electrical power source for the control unit.

**NOTE:** Modular jumper cords are identical to modular voice terminal cords. They have different names in this guide to reflect their different functions and locations in the system.

- To comply with FCC regulations, notify your local telephone company of the following before permanently connecting your system to their lines:
  - System registration number: AS 593M-13529-KF-E
  - Ringer equivalence number: 0.8A
  - Telephone numbers of the lines to which you are connecting your system.

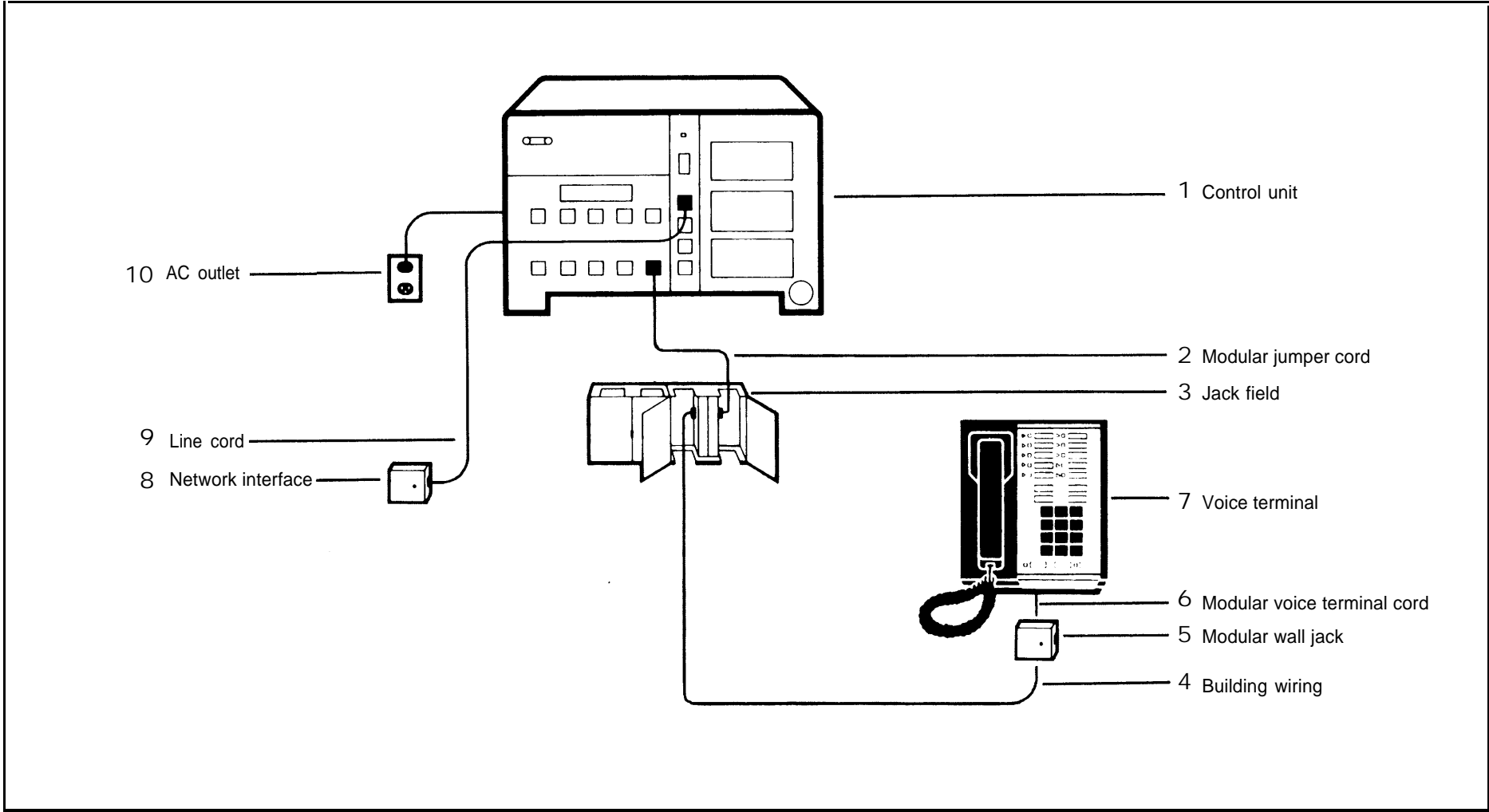

# Installing the Control Unit

Installation procedures are basically the same for both Model 206 and Model 410. The instructions point out only those differences between the models that affect installation.

## POSITION THE CONTROL UNIT

If you plan to wall mount your control unit, follow the instructions in the booklet titled CIB 3029 (for Model 206) or CIB 3030 (for Model 410) in your Control Unit Installation Kit.

Whether you wall mount your control unit or place it on a table or shelf, make sure it's within 5 feet of an ac outlet that is not switch-controlled, within 5 feet of the network interface, and within 6 inches of the jack field, if you have one. The drawing, *right*, provides a diagram for positioning the control unit.

**NOTE:** The ac outlet should be a 117-volt, 60-Hz, 3-prong, third-wire grounded outlet. Proper grounding protects the system against damage from power surges caused by static discharge and lightning. You should have an electrician check the outlet's third wire to make sure the outlet is properly grounded. Power consumption for both models is 40 watts during normal operation.

## SET THE CONTROL UNIT SWITCHES

- 1 Find the Tone/Pulse switch near the top of the center panel on the front of the control unit.
  - If you have rotary (pulse) telephone service, set the switch to *Pulse* (right).
  - If you have Touch-Tone signal telephone service, set the switch to *Tone* (left).
- 2 Find the row of switches labeled Ringing on the left panel of the control unit. Set all of them to *Yes* (up) for now. You may want to reset these switches later when you customize your system.

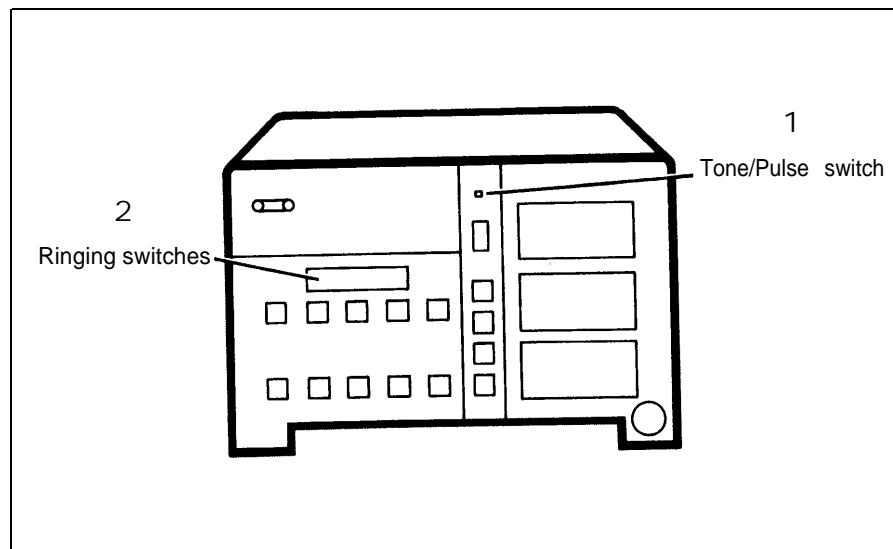
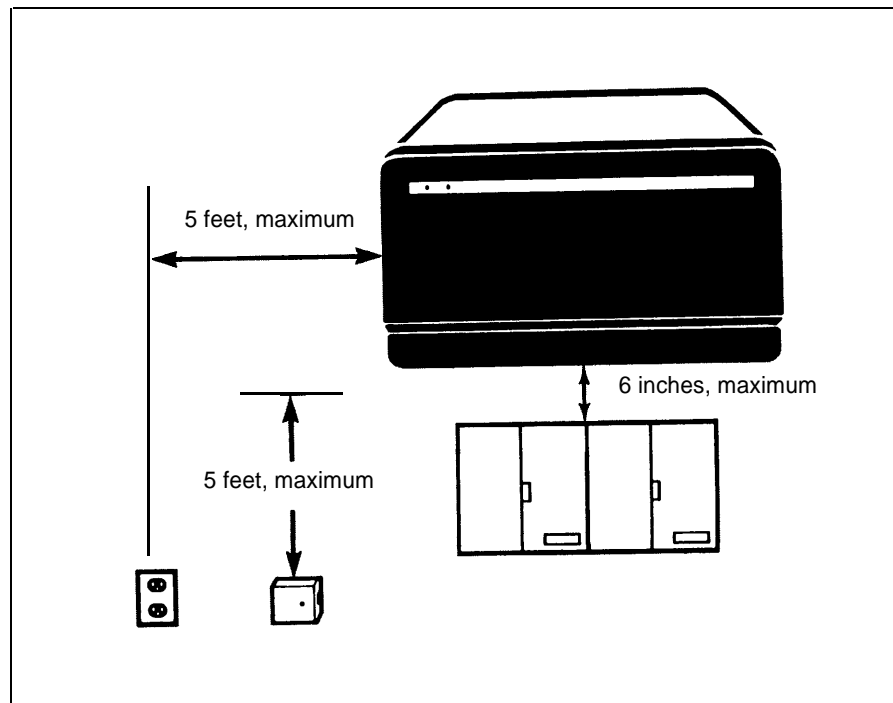

## CONNECT THE CONTROL UNIT TO THE AC OUTLET

The outlet should *not* be switch-controlled. Plugging your control unit into a switch-controlled outlet invites accidental disconnection of the system.

- 1 Find the power cord attached to the control unit and plug it into the ac outlet.

*The green power light on the control unit goes on.*

*The red warning light next to the power light comes on momentarily and then goes off.*

- If the green power light does not come on, test the outlet by plugging in a radio or lamp. If the outlet is working properly, your control unit may be faulty. Contact your equipment supplier for assistance before proceeding with the installation.
  - If the red warning light doesn't blink or remains lit, unplug the power cord and then plug it in again. If the warning light still doesn't operate properly, contact your equipment supplier for assistance before proceeding with the installation.
- 2 Unless otherwise instructed, leave the power cord plugged into the ac outlet throughout the remaining installation procedures.

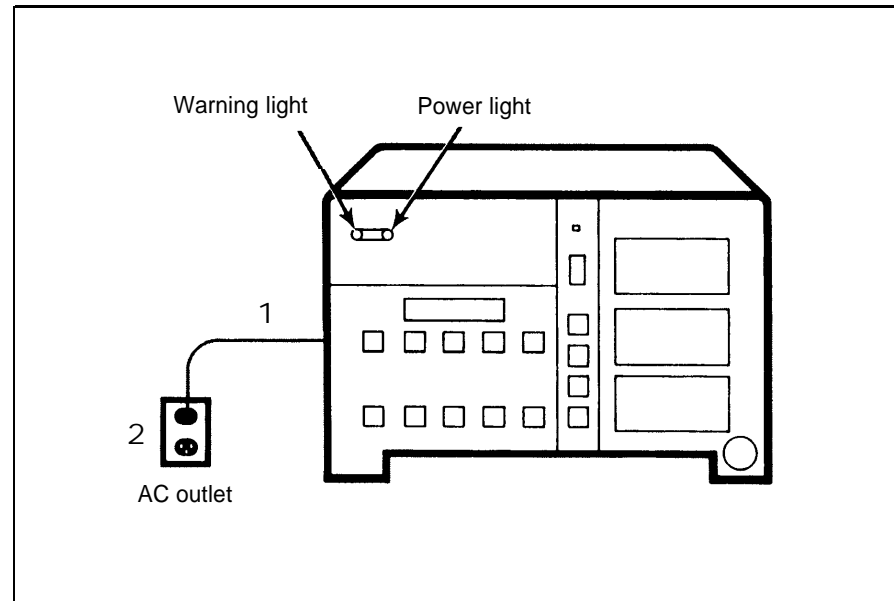



## PREPARE THE NETWORK INTERFACE

Your local telephone company should have installed a network interface with 1-line jacks (RJ11-type) or 2-line jacks (RJ14-type) for connecting your MERLIN system to your outside telephone lines. The drawing, *right*, shows the two types of network interface and the 2-line adapter (267C) for the 2-line network interface jack. The table, *below*, tells you what to do depending on the type of network interface you have.

If the Network Interface	And	Do This
has a 1-line jack (RJ11-type) for each outside line	<p>each jack is labeled with its telephone number</p> <p>each jack is not labeled with its telephone number</p>	<p>Go on to the next section, "Test the Outside Lines," page 9.</p> <ol style="list-style-type: none"> <li>1. Label each jack with its telephone number from the list provided by the local telephone company.</li> <li>2. Go on to the next section, "Test the Outside Lines," page 9.</li> </ol>
has 2-line jacks (RJ14-type) for the outside lines	<p>each jack is labeled with the telephone numbers for its two outside lines</p> <p>each jack is not labeled with the telephone numbers for its two outside lines</p>	<ol style="list-style-type: none"> <li>1. Plug a 2-line adapter (267C) into each jack.</li> <li>2. Go on to the next section, "Test the Outside Lines," page 9.</li> </ol> <ol style="list-style-type: none"> <li>1. Label each jack with the two telephone numbers for its outside lines from the list provided by the local telephone company.</li> <li>2. Plug a 2-line adapter (267C) into each jack.</li> <li>3. Go on to the next section, "Test the Outside Lines," page 9.</li> </ol>

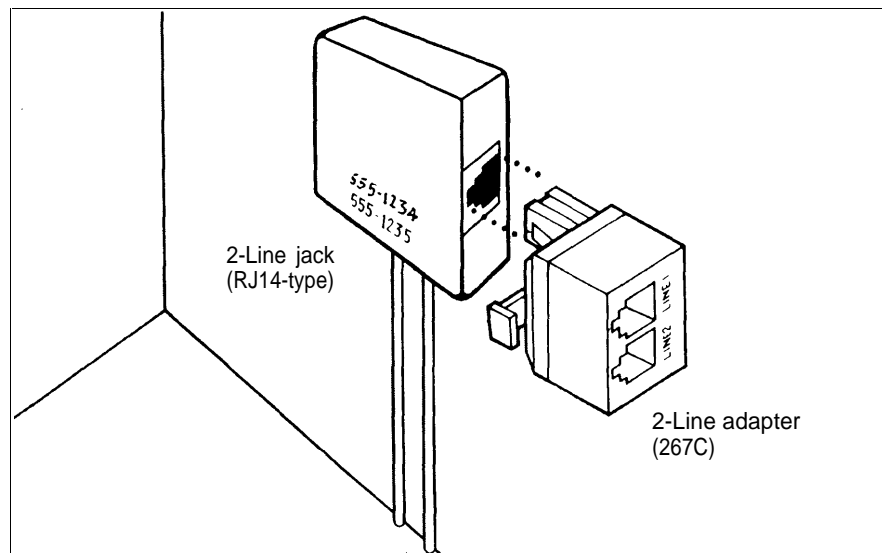
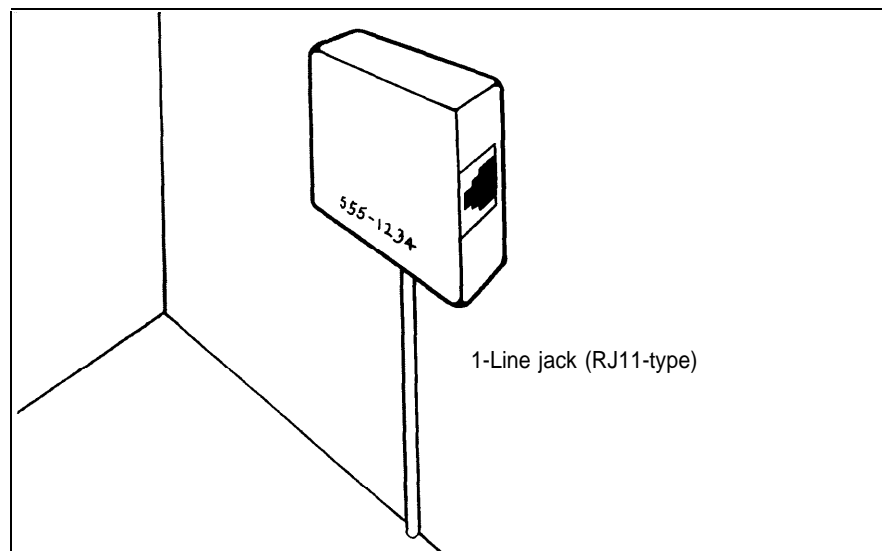

## TEST THE OUTSIDE LINES

This step is optional, but if you have a basic Touch-Tone or rotary telephone with a modular plug, you should test your outside line connections now. It can save time and frustration later.

**NOTE:** A MERLIN system voice terminal will not work for this test.

- 1 Take a basic Touch-Tone or rotary telephone with a modular plug to the network interface.
- 2 Plug the telephone's modular line cord into each outside line jack, and listen for a dial tone.

If	And	Do This
you have tested each outside line	each outside line has a dial tone	Continue with the installation.
a line does not have a dial tone	<p>the jack for that line at the network interface is a 1-line jack (RJ11-type)</p> <p>the jack for that line at the network interface is a 2-line jack (RJ14-type) with a 2-line adapter</p>	<p>Have the local telephone company check the line and the network interface. Meanwhile, continue with the installation.</p> <p>Replace the adapter with another one and try again for a dial tone. If the problem remains, have the local telephone company check the line and the network interface. Meanwhile, continue with the installation.</p>

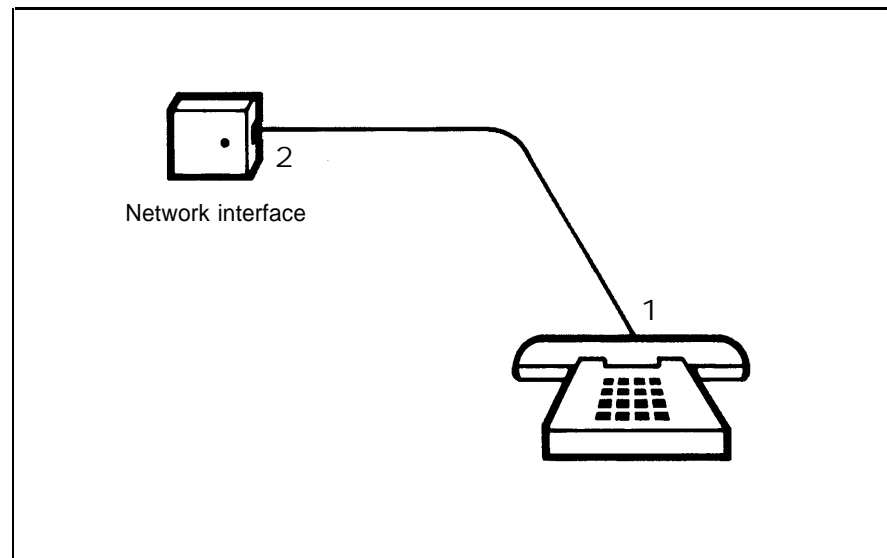

---

## CONNECT THE CONTROL UNIT TO THE NETWORK INTERFACE

When you are assigning outside lines to the outside line jacks on the control unit, keep in mind that the MERLIN system automatically selects lines in alphabetical order for your outgoing calls unless you have a Feature Package and have programmed a different line-selection sequence.

Let's say, for example, that you have a Model 206 with two outside lines. When you lift your handset to dial an outside call, the system selects line A (the line connected to outside line jack A on the control unit) for your call. If line A is busy, it automatically tries line B. Likewise, if you have a Model 410 with four outside lines, the system tries lines A through D in sequence for outgoing calls until it finds an open line. That means line A has more outgoing call traffic than line B, line B has more than C, and so forth.

You probably want to assign your primary or published telephone number to the line in your system with the least outgoing call traffic because it is the one least likely to be busy when an incoming call arrives. That would be line B, for example, for a Model 206 with two outside lines, or line D for a Model 410 with four outside lines.

You need the following items from the Control Unit Installation Kit to connect the control unit to your outside lines at the network interface:

- System directory
- Modular line cords  
You should have one 7-foot cord for each outside line.
- Green-on-white line cord labels  
They're marked A, B, C, etc. You should have a matching pair for each line cord.

Now do this:

- 1 Decide which outside line number to assign to each outside line jack in the control unit.  
**TIP:** The outside line numbers are the telephone numbers listed on the network interface jacks.
- 2 Write the telephone number assigned to each outside line jack in the appropriate space in the system directory.
- 3 Beginning with the pair of labels marked A, label each modular line cord at both ends with matching line cord labels.
- 4 Plug one end of the line cord labeled A into the outside line jack labeled A on the control unit.
- 5 Referring to the system directory, plug the other end of line cord A into the network interface jack labeled with the telephone number you've assigned to line A.
- 6 Follow the same procedure with the remaining line cords until you've connected all your outside lines to the control unit.

**CAUTION:** Do not run cords inside or on top of air plenums or ducts, along hot pipes, or across walkways. If you use staples to attach the cords to a wall or baseboard, be careful not to pierce the cords.

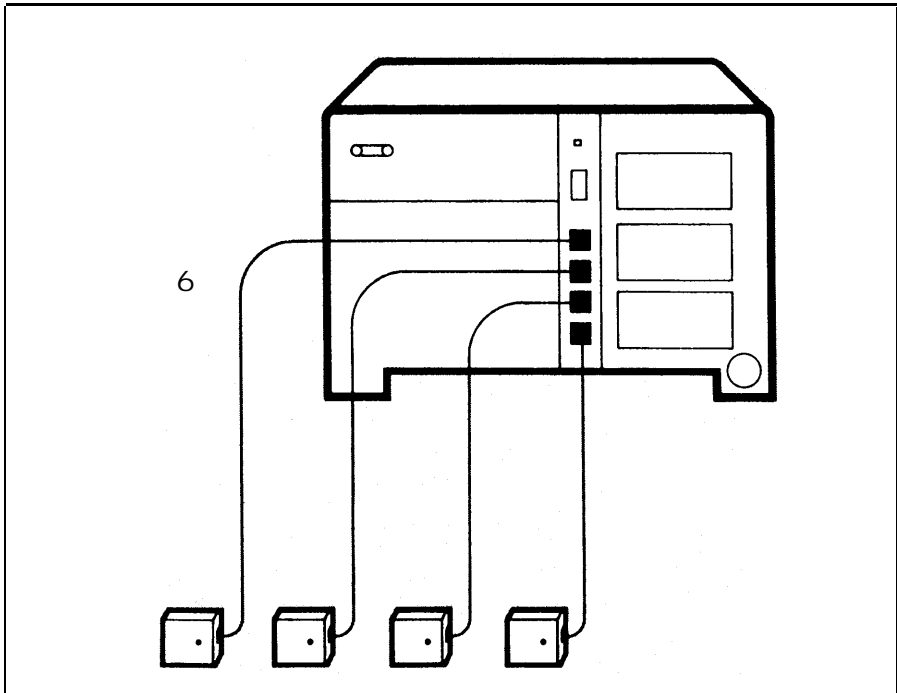
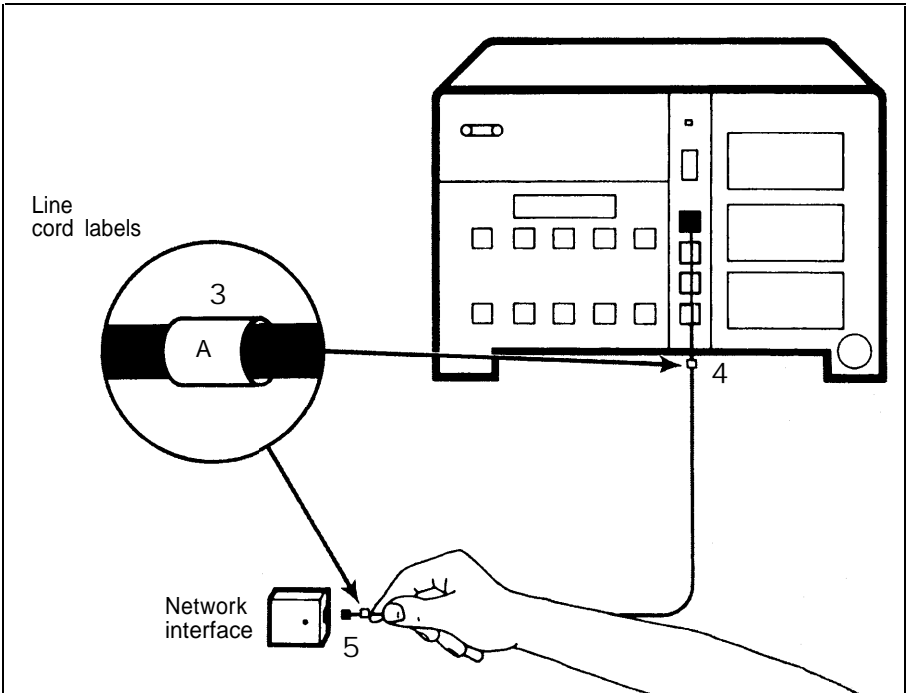
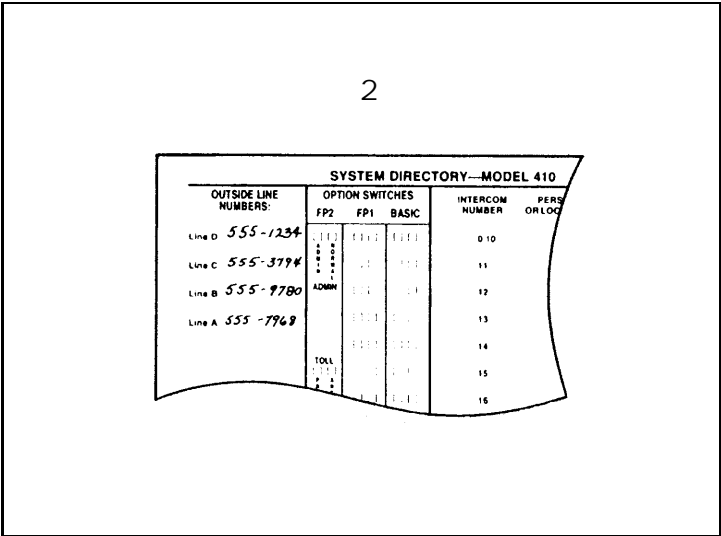
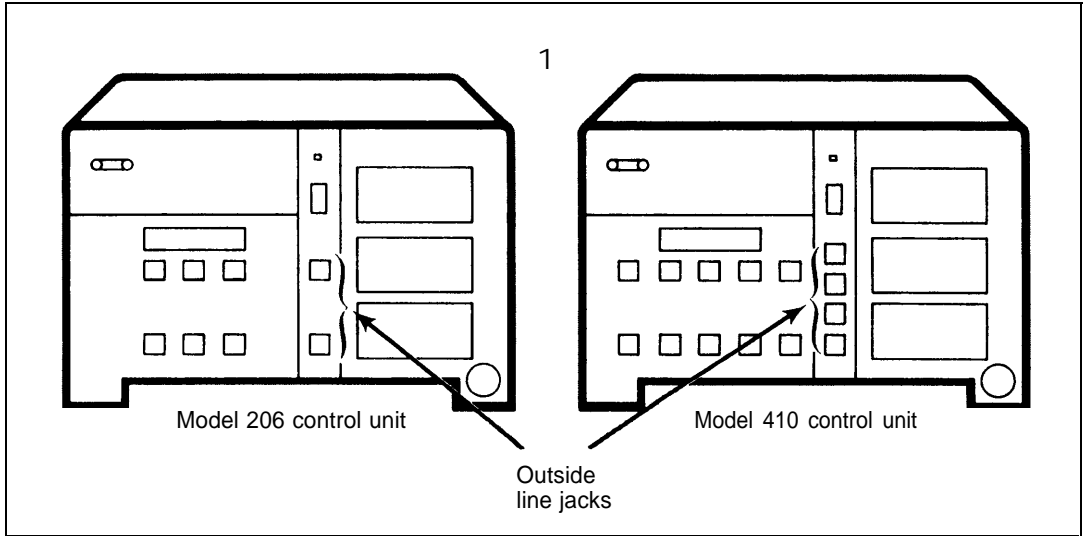

---

# Voice Terminal Wiring

The intercom number for each voice terminal in your MERLIN system is the same as the number of the voice terminal jack on the control unit to which that voice terminal is connected. On a Model 206 control unit, the voice terminal jacks are numbered 0 through 5. On a Model 410 control unit, the voice terminal jacks are numbered 10 through 19. If you want a particular intercom number at a specific location within your business, make a note of the assignment now, before you begin connecting the voice terminal locations to the system.

You can connect your voice terminal locations to the control unit either of two ways: (1) directly, with modular jumper cords and, if needed, modular extension cords; or (2) indirectly, through the building wiring to a jack field at the control unit location.

Whichever procedure you use, you need the following items from the installation kit to complete the connections:

- System directory  
You've already recorded the telephone numbers for your outside lines on it.
- Modular jumper cords  
You should have one 2½-foot cord for each intercom in your system. If you have a professionally installed jack field, these cords may be hanging from the jacks in the jack field. If they are, remove them now.
- Blue-on-white jumper cord labels  
You should have a matched pair for each cord. The label numbers are 0 through 5 for Model 206 and 10 through 19 for Model 410.

The next two sections give instructions for a jack field connection and a direct connection. Go to the section that applies to your system and do what it says.

## JACK FIELD CONNECTION

To connect the control unit to the jack field, do this:

- 1 Open the right door of each jack panel box in the jack field.  
**TIP:** The labeling inside the right door should indicate the wiring run number and endpoint for each jack in the box. Use this labeling as a guide when you fill in your system directory and connect the jacks in the jack field to the voice terminal jacks on the control unit.
- 2 In the system directory, fill in the voice terminal location (the wiring run endpoint) for each intercom number.
- 3 Beginning with the pair of labels marked 0 for a Model 206 or 10 for a Model, 410, label both ends of each jumper cord with matching jumper cord labels.
- 4 Plug one end of the cord labeled with the first intercom number (0 or 10) into the voice terminal jack on the control unit with the same number.
- 5 Following the system directory and the jack field labeling, plug the other end of the cord into the jack in the jack field for the voice terminal location to which you have assigned that intercom number.
- 6 Repeat the procedure for each modular jumper cord, and close the jack panel box doors when you're finished.
- 7 Peel the backing off the system directory, and attach the directory to the inside of the control unit's door
- 8 Fit the door onto the front of the control unit.

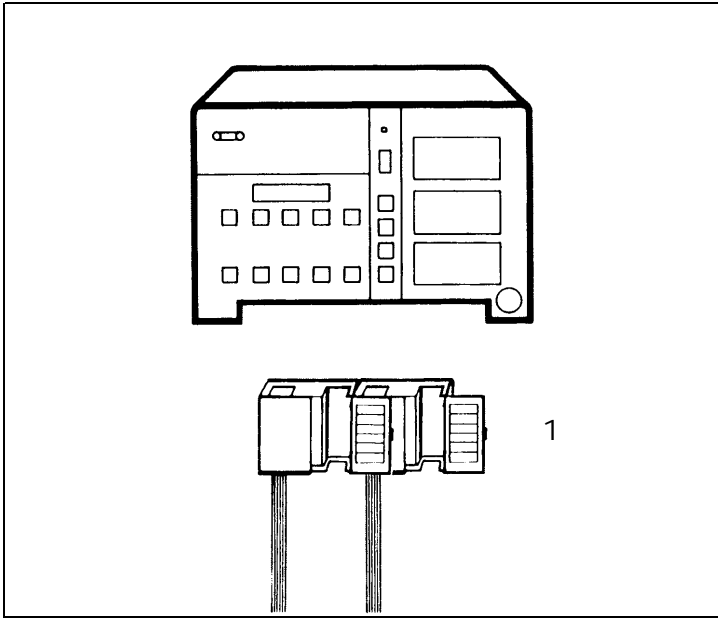

2

SYSTEM DIRECTORY—MODEL 410						
OUTSIDE LINE NUMBERS:	OPTION SWITCHES			INTERCOM NUMBER	PERSON OR LOCATION	WIRING RUN
	FP2	FP1	BASIC			
Line D 555-1234	<input type="checkbox"/>	<input type="checkbox"/>	<input type="checkbox"/>	0/10	SHOP	W 1
Line C 555-3794	<input type="checkbox"/>	<input type="checkbox"/>	<input type="checkbox"/>	11	RECEPTION AREA	W 2
Line B 555-9780	<input type="checkbox"/>	<input type="checkbox"/>	<input type="checkbox"/>	12	STUDIO	W 3
Line A 555-7968	<input type="checkbox"/>	<input type="checkbox"/>	<input type="checkbox"/>	13	SALES ROOM	W 4
	<input type="checkbox"/>	<input type="checkbox"/>	<input type="checkbox"/>	14		W
	<input type="checkbox"/>	<input type="checkbox"/>	<input type="checkbox"/>	15		W
	<input type="checkbox"/>	<input type="checkbox"/>	<input type="checkbox"/>	16		W
	<input type="checkbox"/>	<input type="checkbox"/>	<input type="checkbox"/>	17		W
	<input type="checkbox"/>	<input type="checkbox"/>	<input type="checkbox"/>	18		W

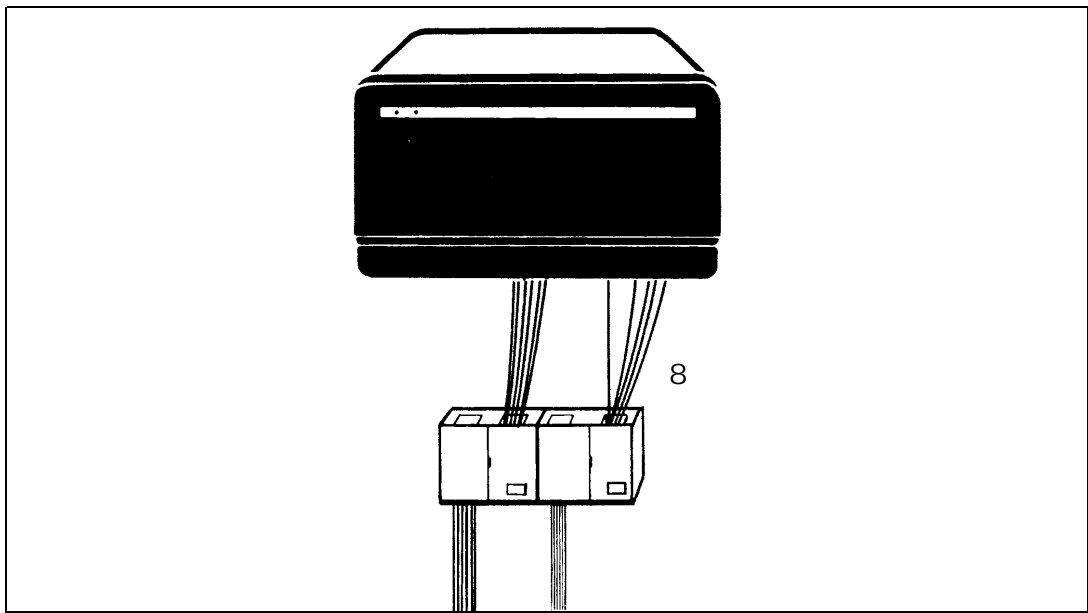
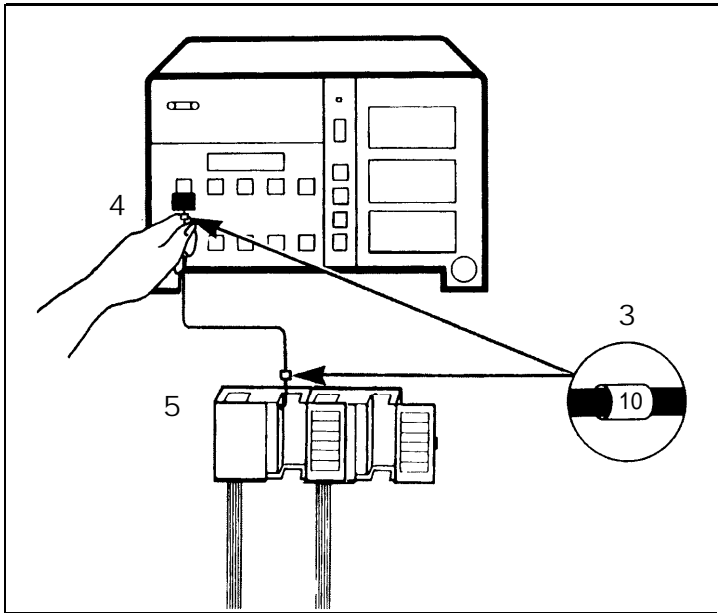

## DIRECT CONNECTION

To connect your voice terminal locations directly to the control unit, do this:

- 1 In the system directory, fill in the voice terminal location you have selected for each intercom number.
- 2 Beginning with the pair of labels marked 0 for Model 206 or 10 for Model 410, label each cord at both ends with matching labels.

**TIP:** If the distance between a voice terminal location and the control unit requires the use of extension cords, label each end of the wiring run. Attach one label near the plug to the voice terminal and the matching label near the plug to the control unit.

- 3 Run the cords from the voice terminal locations to the control unit.

**CAUTION:** Do not run cords inside or on top of air plenums or ducts, along hot pipes, or across walkways. If you use staples to attach cords to walls or baseboards, be careful not to pierce the cords.

- 4 Plug each cord into the voice terminal jack on the control unit with the same number as the cord label.
- 5 Peel the backing off the system directory, and attach the directory to the inside of the control unit's door.
- 6 Fit the door onto the control unit.

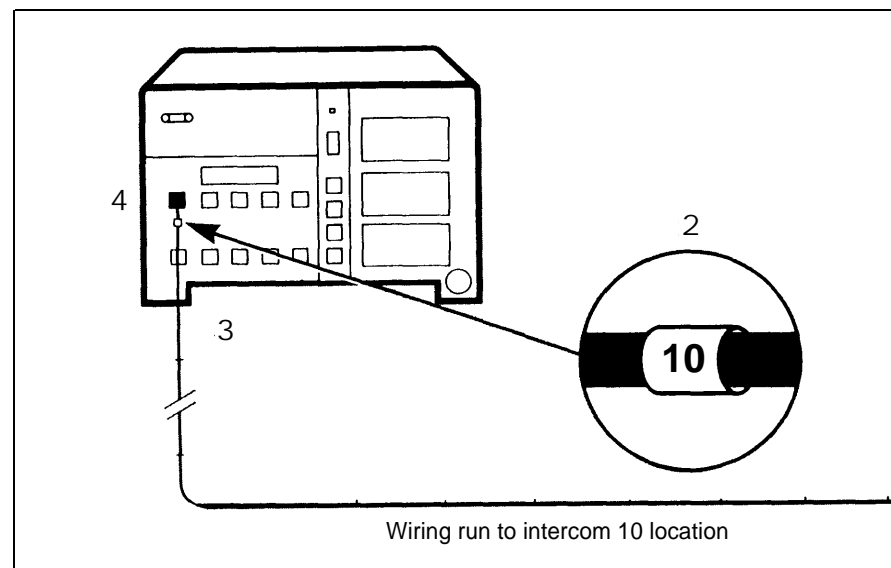
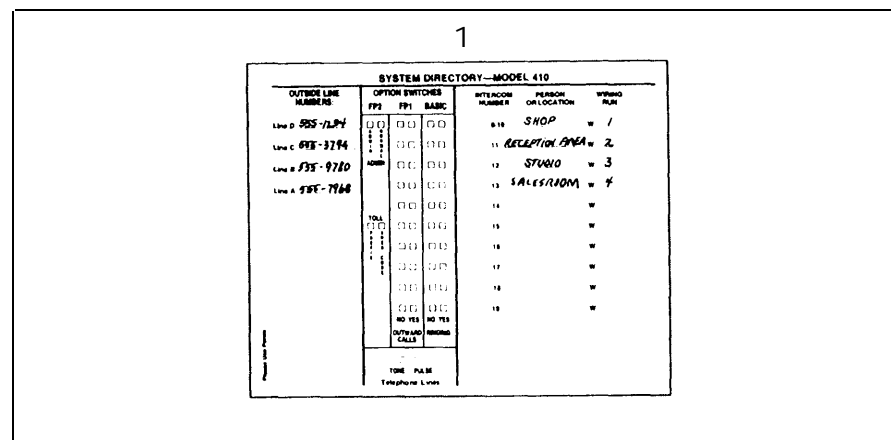

# Connecting the Voice Terminals

Each voice terminal has the following components:

- Voice terminal body
- Handset
- Coiled handset cord
- Modular voice terminal cord
- Desk stand and/or wall mount

## PREPARE THE VOICE TERMINALS

Prepare the voice terminals as follows:

- 1 Assemble each voice terminal and attach the desk stand or wall mount following the instructions that come with the components.
- 2 Plug one end of the coiled handset cord into the handset and the other end into the jack next to the handset symbol at the base of the voice terminal body.
- 3 Plug the modular voice terminal cord into the jack labeled Line on the bottom of the voice terminal.

**NOTE:** If the other end of *this* modular voice terminal cord is already plugged into the control unit (as may be the case for a voice terminal located very close to the control unit), a red light will go on next to a button when you plug the cord into the Line jack on the voice terminal, and the voice terminal may even begin to ring. Don't worry. The red light *should* go on, and step 5, *below*, tells you how to stop the ringing.

- 4 Find the volume control switch on the left side of the voice terminal, and slide it to the center position.
- 5 Find the Test/Program (T/P) switch, also on the left side of the voice terminal, and make sure it's set to the center position. If the switch is set at *T* or *P*, the voice terminal will begin ringing as soon as you plug it in.

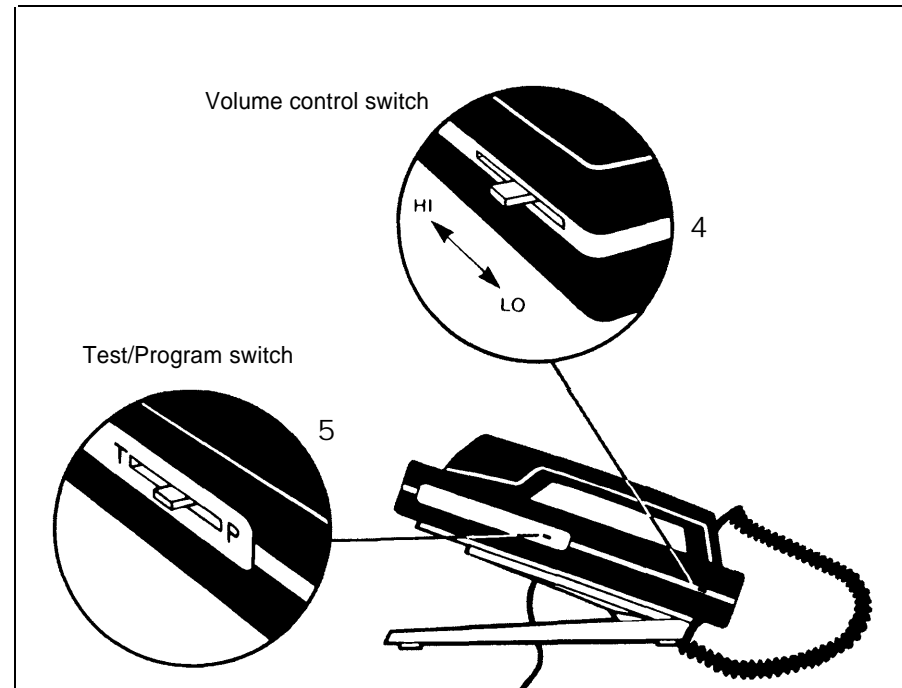
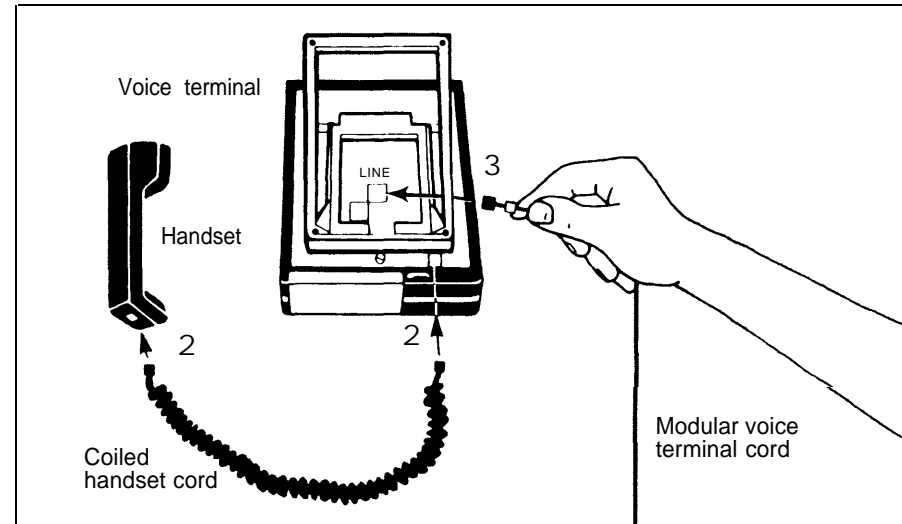



## CONNECT EACH VOICE TERMINAL TO THE SYSTEM

- 1 Place the voice terminal in its designated location.
- 2 Plug the voice terminal into the system in one of the following ways:

If You Have	And	Do This
a direct connection from the voice terminal to the control unit	<p>the connection requires only a single modular voice terminal cord</p> <p>the connection requires one or more modular extension cords</p>	<p>Go on to step 3. You have already connected the voice terminal to the system in step 3 of "Prepare the Voice Terminals," page 15.</p> <p>Plug the loose end of the modular voice terminal cord into the jack on the extension cord that terminates the wiring run from the control unit location. Then go on to step 3.</p>
a jack field connection to the control unit		<p>Plug the loose end of the modular voice terminal cord into the wall jack at the voice terminal location. Then go on to step 3.</p>

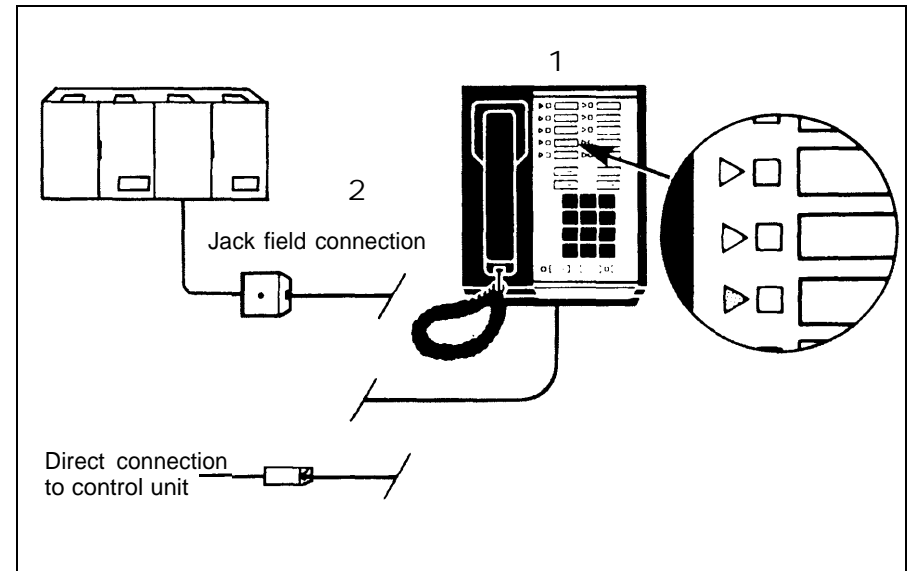

*A red light comes on next to a button when you plug in the voice terminal.*

3 Slide the T/P switch to *T* and hold it there.

*All the red and green lights on the voice terminal begin to flash, and a tone sounds.*

**If the lights do not flash:**

Do This	If	Then
<b>A.</b> Check the green power light on the control unit.	the green power light is on  the green power light is off	go to <b>B.</b>  unplug the power cord from the ac outlet and plug it in again. If the green power light still does not go on, contact your equipment supplier for assistance before continuing with the installation.
<b>B.</b> Check the wiring run from the control unit to the voice terminal.	the wiring connections are stable  you find one or more loose connections	make a note of the problem, and refer to the Troubleshooting Table, page 26, after you've completed the installation.  fix the connections. If the voice terminal lights still do not flash, make a note of it and refer to the Troubleshooting Table, page 26, after you've completed the installation.

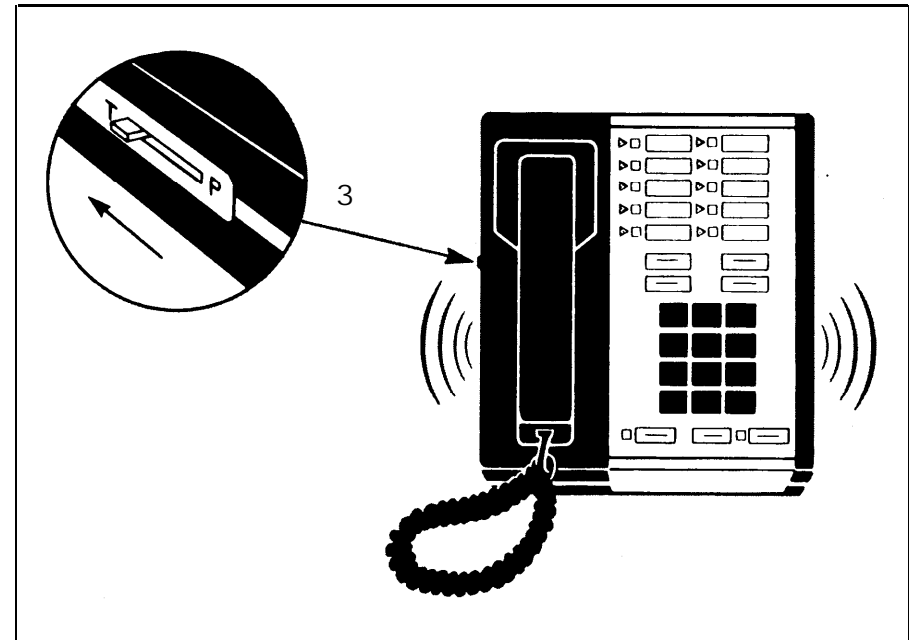

**If the tone does not sound:**

Do This	If	Then
Use the voice terminal's volume control switch to turn up the volume.	the tone sounds  the tone still doesn't sound	you've solved the problem.  make a note of it and refer to the Troubleshooting Table, page 26, after you've completed the installation.

4 Slide the T/P switch to the center position.

*The lights stop flashing and the tone stops.*

## TEST EACH VOICE TERMINAL FOR A DIAL TONE

- 1 Lift the handset.  
*The green light goes on next to the shining red light, and you hear a dial tone.*
- 2 Press one or more of the dial pad buttons.  
*The dial tone stops.*

If your system does not respond as described, make a note of it and refer to the Troubleshooting Table, page 26, after you've completed the installation.

## ATTACH AND VERIFY THE INTERCOM NUMBERS

- 1 Fill in an intercom number label for each voice terminal.
- 2 Pry the plastic number card retainer away from its slot below the handset with a straightened paper clip or similar tool.
- 3 Lay the intercom number label in the slot, and replace the plastic retainer.
- 4 Verify the voice terminal's intercom number:
  - Touch the fifth button down in the leftmost row of buttons (**Intercom-Ring**).
  - Lift the handset.
  - Dial the voice terminal's intercom number.  
*A busy signal verifies the intercom number.*

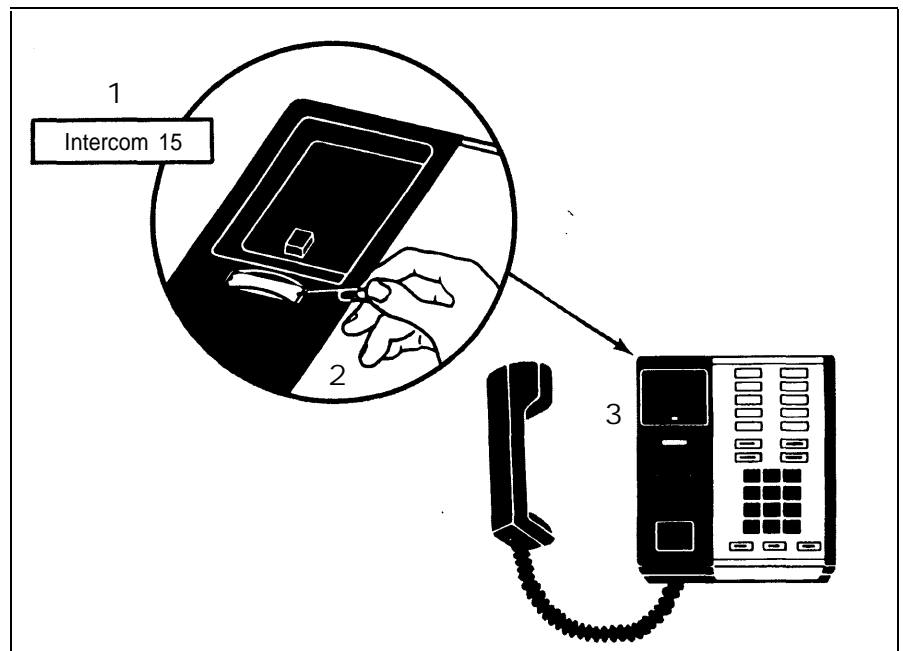
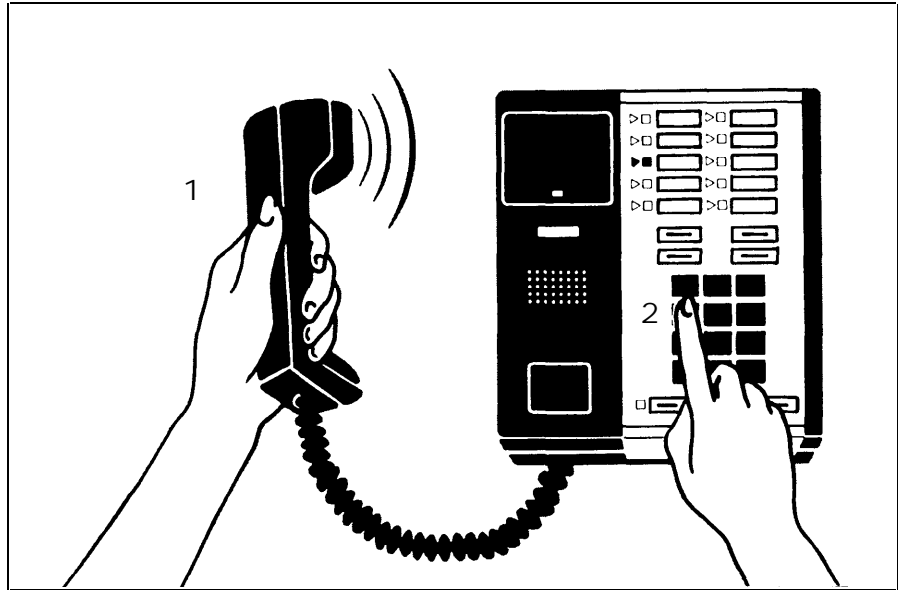

# Installing Accessories

Once you have installed your MERLIN system, you may want to add accessories to enhance your system's capabilities.

## CARTRIDGES

Cartridges provide the software and interfaces that make it possible for you to use many of the MERLIN system features and accessories. Without any cartridges, you will have Standard Features, which include Automatic Line Selection, Push-Button Dialing, Hold, and Intercom. Type I cartridges, called Feature Packages, add features such as Conference Calling, Call Transfer, and Outward Call Restriction to your system. Type II cartridges provide Music-on-Hold and/or Loudspeaker Paging capabilities, and Type III cartridges provide Extra Alert and Power Failure Transfer capabilities.

You can use the same cartridges in both Models 206 and 410, so if you start with the smaller system and your needs grow to the extent that you need the larger system, you don't have to invest in new cartridges. You can simply move them from one control unit to another.

To insert a cartridge, do as follows:

- 1 Unplug the control unit's power cord from the ac outlet.  
**CAUTION: Do not insert or remove cartridges when the control unit is connected to the ac outlet.**
- 2 Match the cartridge type with one of the slot labels on the control unit. (For example, a Feature Package is a Type I cartridge, so find the slot labeled Type I.)
- 3 Remove the protective plastic cover from the slot.
- 4 Slide the cartridge into the slot until the cartridge is firmly seated in place.
- 5 Plug the power cord back into the ac outlet.

*The red warning light on the control unit comes on and then goes off after a few seconds.*

If the red warning light does not go out, the cartridge(s) may not be firmly in place. Try this:

- Unplug the power cord, pull each cartridge from its slot, and push each firmly back into place.
- Plug the power cord back into the ac outlet.

If the warning light still remains lit, contact your equipment supplier for assistance.

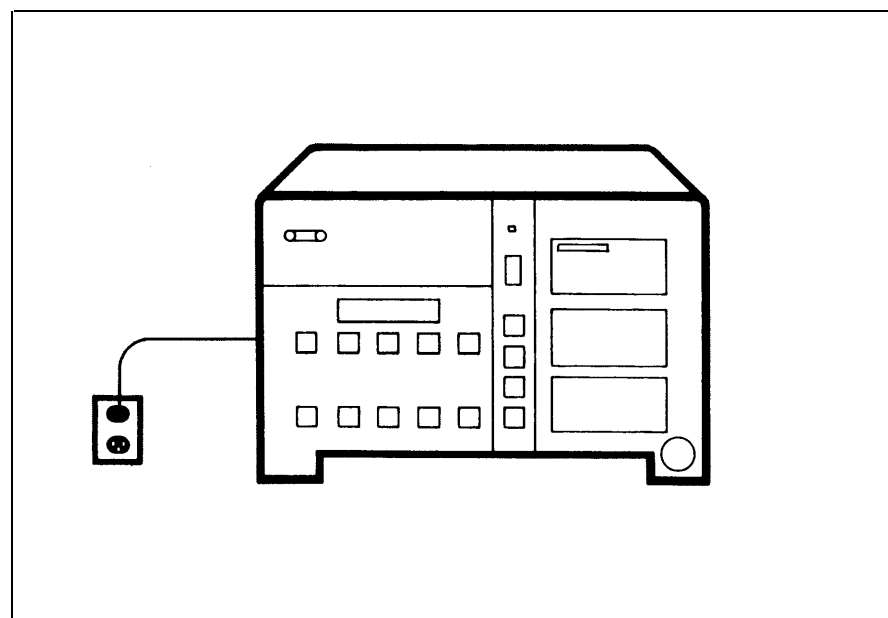
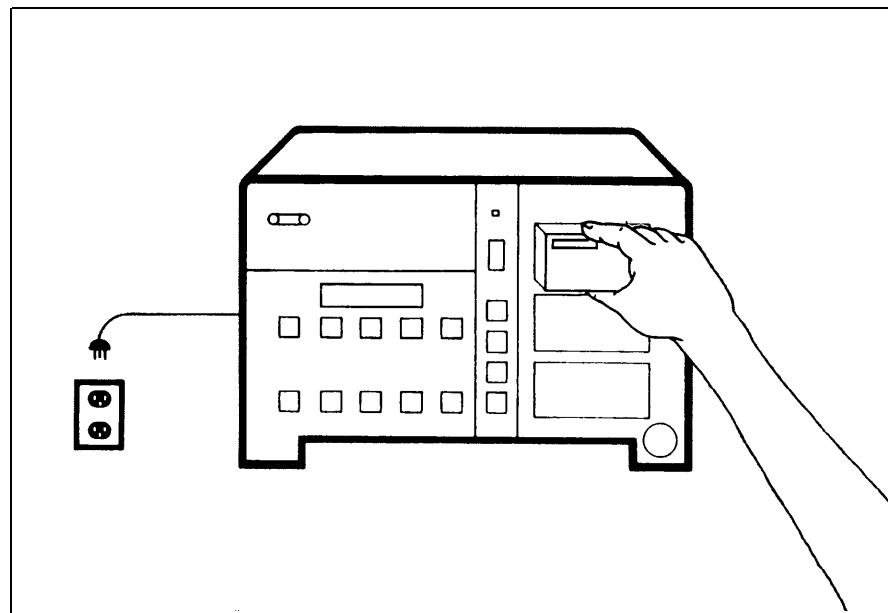

---

## **OTHER ACCESSORIES**

You can enhance your system by adding accessory equipment. Accessories such as Extra Alert horns, Loudspeaker Paging, and Power Failure Transfer telephones require additional cartridges. General Purpose Adapters for your voice terminals allow you to connect modems, autodialers, cordless phones, and other extension phones. You can also connect headsets and Hands-Free Units to your voice terminals.

A 34-button deluxe voice terminal used with an accessory requires a Voice Terminal Power Supply, as does a voice terminal more than 1000 feet from the control unit.

To add these and other accessories to your system, follow the instructions that come with the components.

# System Tests

Now that your system equipment is in place, you need to test it to make sure it's operating properly. The following tests will help you determine if you have installed your system correctly and if all your system components are working. If these tests reveal any problems, see the Troubleshooting Table, page 26.

## PLACE AN OUTSIDE CALL

Using any voice terminal in your system:

- 1 Lift the handset.  
*The green light goes on next to the shining red light.*
- 2 Dial an outside number (for example, a friend's home).
- 3 After the call is answered, place the call on hold by touching **Hold**.  
*The green light next to the line button flashes rapidly.*
- 4 Return to the call on hold by touching the line button next to the flashing green light.
- 5 Verify two-way communication, and then hang up the handset.

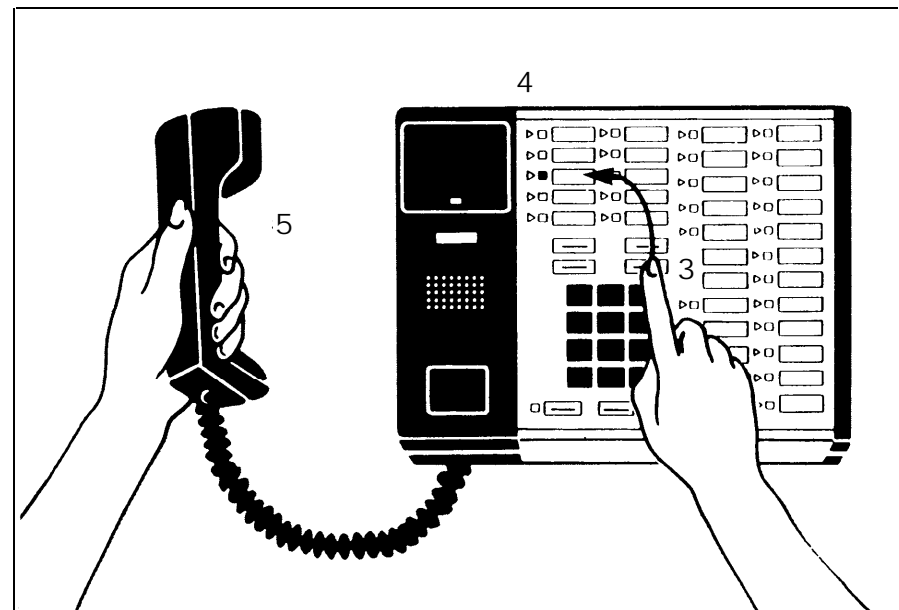
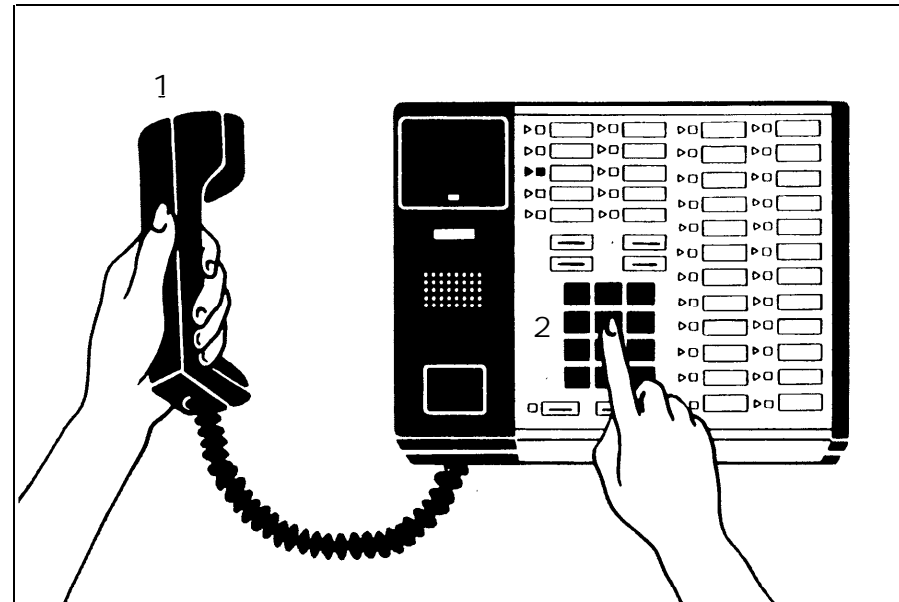

## PLACE AN INTERCOM CALL

Make this test call from one voice terminal to another voice terminal in your system. Have someone available to answer the intercom call.

- 1 From a voice terminal, touch the fifth button down in the leftmost row of buttons (**Intercom-Ring**) without lifting the handset.

*The red light next to the button goes on.*

- 2 Lift the handset.

*The green light next to the button goes on.*

- 3 Dial your partner's intercom number.

*You hear intermittent ringing.*

- 4 Wait for your partner to answer before speaking into your handset.

*When the call comes through on the called voice terminal, three short rings sound, the red light glows steadily next to the fourth button down in the leftmost row of buttons (**Intercom-Voice**), and the corresponding green light flashes until the handset is lifted.*

- 5 When your partner lifts the handset at the called voice terminal, verify two-way communication, and then hang up the handsets at both voice terminals.

*The lights on both voice terminals go out, and the red light goes on next to the third button down in the leftmost row of buttons.*

- 6 Repeat this procedure for every voice terminal you want to test.

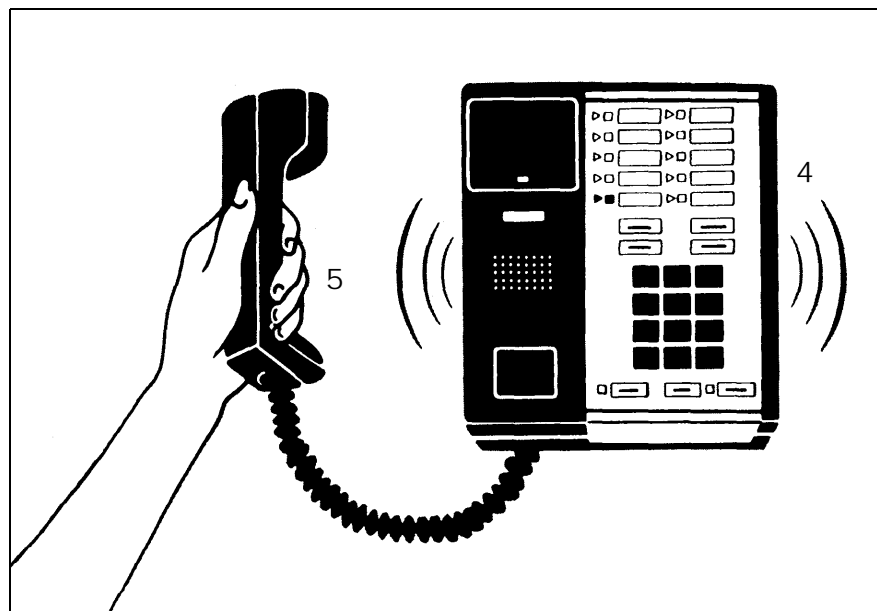
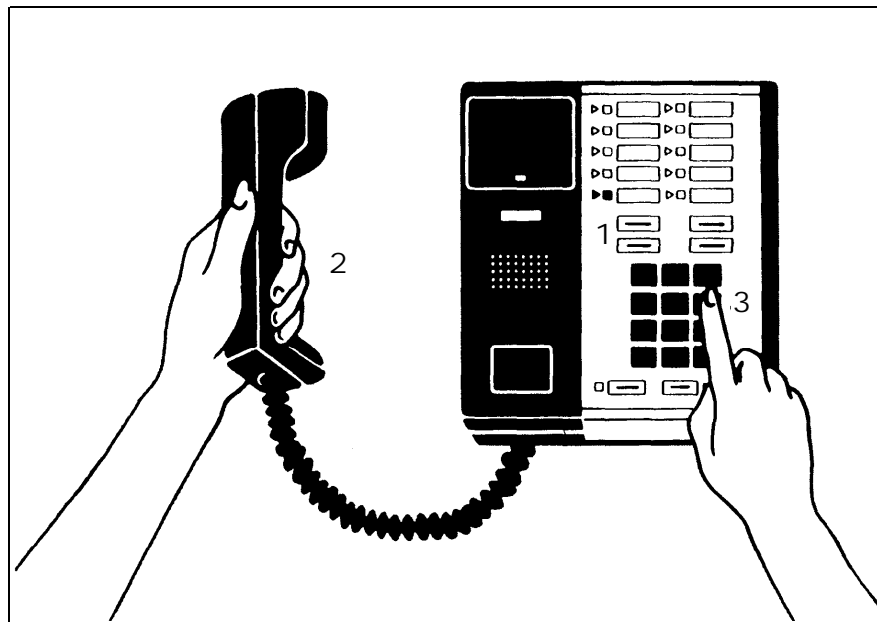

---

## What's Next?

Now that your MERLIN system is installed, you need to program it to meet your business needs. If you have standard features, refer to the *Standard Features User's Guide: Models 206, 410 and 820*. If you have a Feature Package, refer to the administration manual that comes with the Feature Package to learn how to customize the system to meet your business needs. Then, review the user's guide that also comes with the Feature Package to learn how to use the MERLIN system custom features.

This installation guide contains information about system changes and troubleshooting. Keep it for later reference.



---

# System Changes

Your MERLIN communications system is designed so that you can make system changes quickly and easily. You can increase your system's capacity simply by adding outside lines and voice terminals to a maximum of 2 lines and 6 voice terminals for Model 206, and 4 lines and 10 voice terminals for Model 410. You can increase the system's capabilities by adding cartridges and accessories. Modular plugs on much of the system wiring and the labels on key components make it easy for you to reorganize the system in the event of office rearrangements. If your needs increase so much that you need a larger system, you should be able to use many of the components from your present system in your new MERLIN system, which should mean considerable savings.

The following are the most common system changes.

## ADDING AN OUTSIDE LINE

If your MERLIN system becomes so busy that people frequently must wait to make calls, you may want to add an outside line to your system. If you have a Model 206, it can support two outside lines. If you have a Model 410, it can support up to four.

- 1 Have your local telephone company add the outside line(s) and network interface jack(s) to those you already have in place.
- 2 Obtain a modular line cord for each outside line you are adding.
- 3 Unplug the control unit power cord from the ac outlet.
- 4 Follow the instructions for "Prepare the Network Interface," page 8 and, "Connect the Control Unit to the Network Interface," page 10.
- 5 Label a new line button on each voice terminal that will have access to the new line. See your administration manual for more detailed information on how to assign an outside line to a voice terminal and which button to label.
- 6 Record the change in your system directory.

## ADDING A VOICE TERMINAL

You can easily add more voice terminals to your MERLIN system as your business and communication demands increase. A Model 206 can support up to six voice terminals; a Model 410 can support up to ten.

- 1 See that the necessary wiring, jacks, and modular voice terminal cords are installed between the control unit and the new voice terminal location. (See "Getting Started," page 3, and "Voice Terminal Wiring," page 12.)

- 2 Assemble each new voice terminal, and connect it to the system according to the instructions in "Connecting the Voice Terminals," page 15.
- 3 Record the addition in your system directory.

## MOVING A VOICE TERMINAL

You can easily move a voice terminal from one location to another without having to reprogram the voice terminal.

To move a voice terminal:

- 1 Make sure the necessary wiring is in place (see "Getting Started," page 3, and "Voice Terminal Wiring," page 12).
- 2 Unplug the voice terminal at its old location, and plug it in at the new location.
- 3 Change the connection at the control unit location:
  - If you have a jack field, unplug the jumper cord labeled with the voice terminal's intercom number from the jack in the jack field for the voice terminal's old location, and plug it into the jack for its new location. You do not have to change any labels in the system. Simply record the change of location in the system directory.
  - If you have a direct connection from the new location to the control unit, find the modular cord that terminates the wiring run from the voice terminal's new location to the control unit, and plug that cord into the voice terminal jack in the control unit with the voice terminal's intercom number. This procedure for a direct connection requires you to relabel both ends of the wiring run between the *new* location and the control unit with the voice terminal's intercom number and record the change in the system directory. But you do not have to reprogram the voice terminal.

## CHANGING TOUCH-TONE/ROTARY SERVICE

If you are changing your telephone service from rotary (pulse) to Touch-Tone:

- Set the Tone/Pulse switch on the control unit to *Tone* (left).

If you are changing your telephone service from Touch-Tone to rotary (pulse):

- Set the Tone/Pulse switch on the control unit to *Pulse* (right).

---

## UPGRADING FROM MODEL 206 TO MODEL 410

If your needs expand beyond the capacity of your Model 206 system, you can easily install a Model 410 system in its place. You can reuse the cartridges, voice terminals and accessories that came with your Model 206.

- 1 Have your local telephone company add outside line(s) and network interface jack(s) to those you already have. If you have building wiring with modular jacks, have additional building wiring professionally installed, or install it yourself using the Wiring Installation Kit.
- 2 Obtain the following components:
  - Model 410 control unit
  - Line cords and line cord label pairs for each new wiring run
  - Additional voice terminals
  - Modular voice terminal cords and terminal cord labels for each new voice terminal.
- 3 Unplug the Model 206 power cord from the ac outlet.
- 4 Unplug all the modular voice terminal cords and line cords from the Model 206 control unit.
- 5 Slide the cartridges out of the control unit.
- 6 Remove the Model 206 control unit and put the Model 410 control unit in its place.
- 7 Insert the cartridges into the new control unit following the instructions described in "Installing Accessories," page 19.

**CAUTION:** Do not insert or remove cartridges when the control unit power cord is plugged into the ac outlet.

- 8 Plug your original line cords into the control unit line jacks that match the cords' labels.
- 9 Label new line cords at both ends with the letters associated with the empty control unit line jacks.
- 10 Assign new intercom numbers to your voice terminals; 10 through 19 are the available intercom numbers with Model 410.
- 11 Label the modular voice terminal cords with their new intercom numbers.
- 12 Plug your original modular voice terminal cords into the voice terminal jacks that match the cords' labels.
- 13 Install your new voice terminal wiring following the instructions in "Voice Terminal Wiring," page 12.
- 14 Assemble your new voice terminals and place them in their new locations. Add new intercom labels to voice terminals. Follow the instructions in "Connecting the Voice Terminals," page 15.
- 15 Fill out a new system directory and attach it to the control unit door.
- 16 Refer to "What's Next," page 23, to find out where you can learn how to administer and program your new Model 410 system to meet your individual business needs.

# Troubleshooting

Refer to the following table if you have trouble with your MERLIN system. Identify the symptom in the “Trouble” column of the table, and perform the recommended steps to isolate and correct the problem. If you are unable to identify a particular problem, perform the general test on page 29 before calling your equipment supplier for help. Once you have programmed and administered your system, you may want to obtain the *Service and Maintenance Manual: Models 206, 410, and 820* for additional information on troubleshooting your system.

**TROUBLESHOOTING TABLE**

Trouble	Possible Cause	Do this	If	Then
You have difficulty placing outside calls from more than one voice terminal.	Incorrect Tone/Pulse setting	1. Check the Tone/Pulse switch setting on the control unit.	the switch is set to <i>Pulse</i> and you have Touch-Tone telephone service	set the switch to <i>Tone</i> .
			the switch is set to <i>Tone</i> and you have rotary (pulse) telephone service	set the switch to <i>Pulse</i> . This corrects the setting but does not solve this problem. Go to step 2.
			the switch is set for the appropriate telephone service	go to step 2.
	Call Restriction feature activated on the malfunctioning voice terminals	2. Refer to the administration manual to learn how to administer the Call Restriction feature.	the feature is activated on the malfunctioning voice terminals	deactivate the feature following the instructions in the administration manual.
			the feature is not activated on the malfunctioning voice terminals	go to step 3.
	Faulty MERLIN system components	3. Try to place both outside and intercom calls from several voice terminals.	the trouble appears on intercom calls or the trouble appears on only one voice terminal	the trouble is caused by a component in your system. Refer to the other tests in this table to identify the source of the problem.
			the trouble appears only on outside calls	go to step 4.
	Faulty telephone company wiring	4. At the control unit location, unplug the line cords from the network interface, and in their place plug in a basic telephone. (Do not use a MERLIN system voice terminal.) Try to place an outside call from each network interface jack.	the trouble appears on the basic telephone, and the interface uses a line adapter	go to step 5.
the trouble appears on the basic telephone, and the interface does not have a line adapter			your outside telephone lines are faulty. Report the trouble to your local telephone company representative.	

## TROUBLESHOOTING TABLE (CONTINUED)

Trouble	Possible Cause	Do this	If	Then
You have difficulty placing outside calls from more than one voice terminal. (continued)	Faulty network interface line adapter	5. Replace the network interface line adapter with another one. Plug the basic telephone into each of the jacks, and try to place an outside call.	the trouble still appears on the basic telephone	your outside telephone lines are faulty. Report the trouble to your local telephone company representative.
			the trouble does <i>not</i> appear on the basic telephone	the old line adapter is faulty. Replace it with a new line adapter.
A voice terminal doesn't ring.	Volume control switch	1. Check the volume control setting on the voice terminal. Slide the switch to a higher setting.	the trouble persists	go to step 2.
	Voice terminal programmed not to ring	2. Refer to the user's guide to learn how to program ringing options.	voice terminal is programmed not to ring	change the ringing option according to the instructions in the user's guide.
			the voice terminal is programmed to ring	go to step 3.
	Do Not Disturb feature is activated (applies only if you have a Feature Package)	3. Refer to the user's guide that came with the Feature Package.	the feature is activated	deactivate the feature following the instructions in the User's Guide.
			the feature is not activated	refer to the test for "Trouble with lights, speaker, and ringing."
	There is trouble with voice terminal lights, speaker, or ringing.	Faulty voice terminal	1. Slide the T/P switch on the side of the voice terminal to the <i>T</i> position and hold it there.	all the red and green lights flash alternately, and a tone sounds continually
some (but not all) of the lights flash continually and/or a tone sounds at irregular intervals				the trouble is caused by either the voice terminal or the cord connection. Go to step 2.
all lights are off and a tone sounds continually or irregularly				the trouble is either the control unit, the voice terminal, or the cord connection. Go to step 2.
2. Unplug the malfunctioning voice terminal, and in its place plug in a working voice terminal. Slide its T/P switch to the <i>T</i> position and hold it there.			the same trouble appears on the working voice terminal	the malfunctioning voice terminal probably is not faulty. The trouble is in either the control unit or the cables. Plug the malfunctioning voice terminal into its original jack and go to step 3.
			the trouble does <i>not</i> appear on the working voice terminal	the malfunctioning voice terminal is faulty. Contact your equipment supplier for assistance.

**TROUBLESHOOTING TABLE (CONTINUED)**

Trouble	Possible Cause	Do this	If	Then
There is trouble with voice terminal lights, speaker, or ringing. (continued)	Control unit	3. Go to the control unit and locate the intercom jacks for both the malfunctioning and working voice terminals. Unplug both from the control unit, and replug both into the other's jack. See if the trouble occurs on the working voice terminal.	the trouble still occurs	the problem is caused by your control unit. Call your equipment supplier for assistance.
			the trouble no longer occurs	the trouble is caused by one of the cords running to the malfunctioning voice terminal. Go to step 4.
	Cord connections	4. Replace each cord, one at a time, and test the malfunctioning voice terminal.	the trouble still occurs	the cause is inadequate power to the control unit Go to step 5.
			the trouble no longer occurs	you've found the faulty cord.
	Inadequate power supply to the control unit	5. Unplug some of the accessories connected to your system.	the trouble remains	the problem is caused by your control unit or the building wiring. Call your equipment supplier for assistance.
			the trouble no longer occurs	you need one or more Voice Terminal Power Supply units. Refer to "Installing Accessories," page 19. Call your equipment supplier. <i>Leave accessories unplugged</i> until you have the necessary power.
A voice terminal rings constantly.	Voice terminal T/P switch is not set in center position	Check the position of the T/P switch.	it is set at either <i>T</i> or <i>P</i>	slide it to the center position.
			it is in the center position	your voice terminal is faulty. Unplug it from the modular jack and contact your equipment supplier for assistance.
All voice terminals have no lights and no dial tone.	Control unit	1. Check the green power light on the control unit.	the green power light is on	go to step 2.
			the green power light is off	go to step 4.
		2. Check the red warning light on the control unit.	the red warning light is off	go to step 3.
			the red warning light is on	go to step 4.

## TROUBLESHOOTING TABLE (CONTINUED)

Trouble	Possible Cause	Do this	If	Then
All voice terminals have no lights and no dial tone. (continued)	Faulty power outlet	3. Test the outlet by plugging in an appliance such as a lamp or a radio.	the appliance doesn't work	the outlet is faulty or controlled by a wall switch.
			the appliance works	the control unit is faulty. Call your equipment supplier for assistance.
	A cartridge is loose and/or the control unit needs to be reset.	4. Unplug the control unit. Remove and replace each cartridge, making sure each is securely seated in its slot. Plug the control unit back in.	the red warning light goes out	the problem is solved. One of the cartridges was not securely in place and/or the control unit needed to be reset.
			the red warning light remains on	call your equipment supplier for assistance.

## GENERAL TEST

If you are experiencing a problem not described in the previous tests, or if none of the tests reveal a specific problem, try the following procedure before calling your equipment supplier.

Trouble	Possible Cause	Do this	If	Then
The system isn't working properly and the trouble isn't described in the Troubleshooting Table.	A cartridge may be loose and/or the control unit may need to be reset.	Unplug the control unit. Pull out each cartridge and reinsert it, so that each cartridge is securely seated in its slot. Plug the control unit back in.	the trouble is gone	you have corrected the problem.
			the trouble remains	call your equipment supplier.

---

## Appendix A: Interference Information

According to Federal Communications Commission (FCC) Rules, you need to know that:

- This equipment generates, uses, and can radiate radio frequency energy and, if not installed and used in accordance with this installation guide, may cause interference to radio communications.
- The equipment has been tested and found to comply with the limits for a Class A computing device pursuant to Subpart J of Part 15 of FCC Rules, which are designed to provide reasonable protection against such interference when operated in a commercial environment.
- Operating this equipment in a residential area is likely to cause interference, in which case the user, at his or her own expense, will be required to take whatever measures may be required to correct the interference.

## Appendix B: FCC Registration and Repair Information

This equipment is registered with the FCC in accordance with part 68 of its Rules. In compliance with the Rules, you are to be advised of the following:

- *Means of Connection:* Connection of this equipment to the telephone network must be through several standard network interface jacks USOC RJ11C or RJ14C. You can order these from your local telephone company. This equipment may not be used with party lines or coin telephone lines.
- *Notification of the Local Telephone Company:* Before connecting this equipment, you or your equipment supplier must notify your local telephone company's business office. Tell them the:
  - Telephone numbers you will be using with this equipment
  - Equipment's registration number and the ringer equivalence number (REN)

You must notify your local telephone company if and when this equipment is permanently disconnected from the line(s).

- *Installation and Operational Procedures:* This guide and the administration manual contain information about installation and operational procedures.
- *Repair Instructions:* If you experience trouble because your equipment is malfunctioning, the FCC requires that the equipment not be used and that it be disconnected from the network until the problem has been corrected. Repairs to this equipment can only be made by the manufacturers, their authorized agents, or by others who may be authorized by the FCC.
- *Rights of the Local Telephone Company:* If this equipment causes harm to the telephone network, the local telephone company may discontinue your service temporarily. If possible, they will notify you in advance. But if advance notice is not practical, you will be notified as soon as possible. You will also be informed of your right to file a complaint with the FCC.

Your local telephone company may make changes in its facilities, equipment, operations, or procedures that affect the proper functioning of this equipment. If they do, you will be notified in advance to give you an opportunity to maintain uninterrupted telephones service.

- *Hearing Aid Compatibility:* The custom telephone sets for this system are compatible with inductively coupled hearing aids as prescribed by the FCC.

---

# Index

- AC Outlet, 4, 5, 6, 7
- Accessories, **19, 20**
  - Autodialer, 20
  - Extra Alert, 19, 20
  - Hands-Free Unit, 20
  - Headset, 20
  - Voice Terminal Power Supply, 20
- Administering the MERLIN System, **2, 6, 23, 24**
- Airborne Contamination, **4**
- Building Wiring, **3, 4, 5, 12, 25**
- Call Transfer, **19**
- Cartridges, 4, **19, 24, 25**
- Conference Calling, **19**
- Control Unit, **2 - 7, 10 - 15, 19, 24, 25**
  - Cartridges, 4, 19, 24, 25
  - Environmental Requirements, 4
  - Installing, 6 - 11
    - Positioning, 6
    - Power Light, 7
    - Switches, 6
    - Wall Mounting, 6
    - Warning Light, 7
- Control Unit Installation Kit, **6, 10, 12**
- Customer Information Booklets (CIBs), **6**
- Desk Stand, **15**
- Direct Connection, **12, 14, 16**
- Extra Alert, **19, 20**
- Feature Packages, 10, **19, 23**
- Federal Communications Commission (FCC), **4, 30**
  - FCC Rules, 4, 30
- General Purpose Adapter, 20
- General Test, **29**
- Grounding, **6**
- Hands-Free Unit, **20**
- Handset, **15**
- Handset Cord, **15**
- Headset, **20**
- Hold, **19**
- Humidity, **4**
- Installing the Control Unit, **6 - 11**
- Inserting a Cartridge, **19**
- Intercom, **18, 19, 22**
- Intercom Number Labels, **18**
- Intercom Numbers, **12, 13, 18**
- Jack Field, **3, 4, 5, 6, 12, 13, 16**
- Jack Field Connection, 3, **12, 13, 16**
- Jack Panel Boxes, **3, 12, 13**
- Jumper Cords, 4, 5, **12, 13**
- Labels, 3, **10, 11, 12, 13, 24, 25**
- Lightning, **6**
- Lights, **7, 16, 17, 18, 21, 22**
  - Power Light, 7
  - Voice Terminal Lights, 16, 17, 18, 21, 22
  - Warning Light, 7
- Line Cords, 4, 5, **10, 11**
- Local Telephone Company, **4, 8, 30**
- Modems, **20**
- Modular Jumper Cords, 4, 5, **12, 13**
- Modular Line Cords, 4, 5, **10, 11**
- Modular Voice Terminal Cords, 3, 4, 5, **14, 15, 16**
- Modular Voice Terminal Extension Cords, 3, **14, 16**
- Modular Wall Jacks, **4, 5, 16**
- Music-on-Hold, **19**
- Network Interface Jacks, 4, 5, 6, **8, 9, 10, 11, 24, 25, 30**
  - 1-Line, 8, 30
  - 2-Line, 8, 30
- Operating Temperatures, **4**
- Outside Line Jacks, 9, **10, 11**
- Outside Lines, 4, **9, 10, 11**
- Outward Call Restriction, **19**
- Paging, **20**
- Power Accessories, **20**
- Power Consumption, **6**
- Power Cord, **7**
- Power Failure Transfer, **19**
- Power Surges, **6**
- Programming Instructions, **23**
- Pulse (Rotary) Service, **6, 24**
- Push-Button Dialing, **19**
- Ringer Equivalence Number (REN), **4, 30**
- Rotary (Pulse) Service, **6, 24**
- Standard Features, **19**
  - Automatic Line Selection, 19
  - Push-Button Dialing, 19
  - Hold, 19
  - Intercom, 18, 19, 22
- Static Discharge, **6**
- System Changes, **24, 25**
- System Directory, **10, 11, 12, 13, 14**
- System Labeling, 3, **10, 11, 12, 13, 14, 24, 25**
- System Registration Number, **4, 30**
- System Tests, **21, 22**
- System Wiring, **3, 4, 5, 10 - 16**
- Telephone Numbers, **8, 10, 11**
- Test/Program (T/P) Switch, **15, 17**
- 34-Button Deluxe Voice Terminal, **20**
- Tone/Pulse Switch, **6, 24**
- Touch-Tone Service, **6, 24**
- Troubleshooting Table, **26 - 29**
- 2-Line Adapter, **8**
- Upgrading to Model 410, **25**
- User's Guide, **23**
- Ventilation, **4**
- Voice Terminal Jacks, **12, 13, 14, 21, 22, 24**
- Voice Terminals, 2, 45, **12 - 18**
  - Handset, 15
  - Handset Cord, 15
  - Headset, 20
  - Lights, 16, 17, 18, 21, 22
  - Line Jack, 15
  - Modular Voice Terminal Cord, 4, 5, 14, 15, 16
  - T/P Switch, 15, 17
  - Volume Control Switch, 15
  - Wall Mount, 15
- Voice Terminal Extension Cords, 3, **14, 16**
- Voice Terminal Power Supply, **20**
- Wall Jacks, **4, 5, 16**
- Warning Light, **7**
- Warranty, **4**
- Wiring Runs, **3, 12, 13, 14**





AT&T

MERLIN is a registered trademark of AT&T  
© Copyright 1986 AT&T. Printed in U.S.A.

518-600-000 IS

Issue 5

July 1986